

FST-1390

+ Laser cutting machine



New lifting platform



Brand laser tube



Water protection switch



Multi-document function



Offline use

DETAIL DISPLAY

LASER

LIAOCHENG FOSTER LASER SCIENCE & TECHNOLOGY CO., LTD.

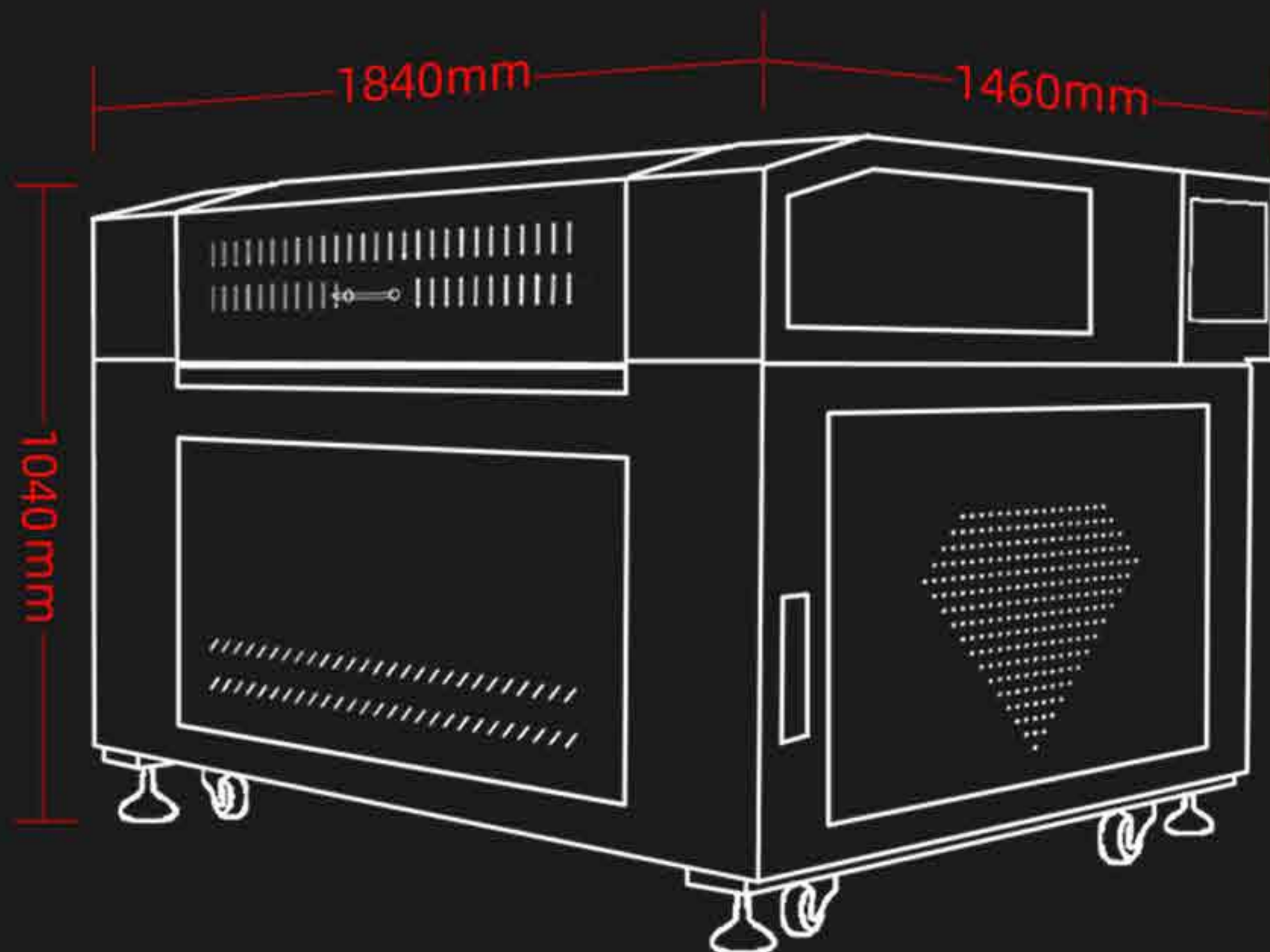

Thickened casing, Thickness up to 3mm.

1300X900MM WORK AREA

laser cutting machine

ALUMINUM KNIFE

To process hard materials like acrylic, wood and so on.

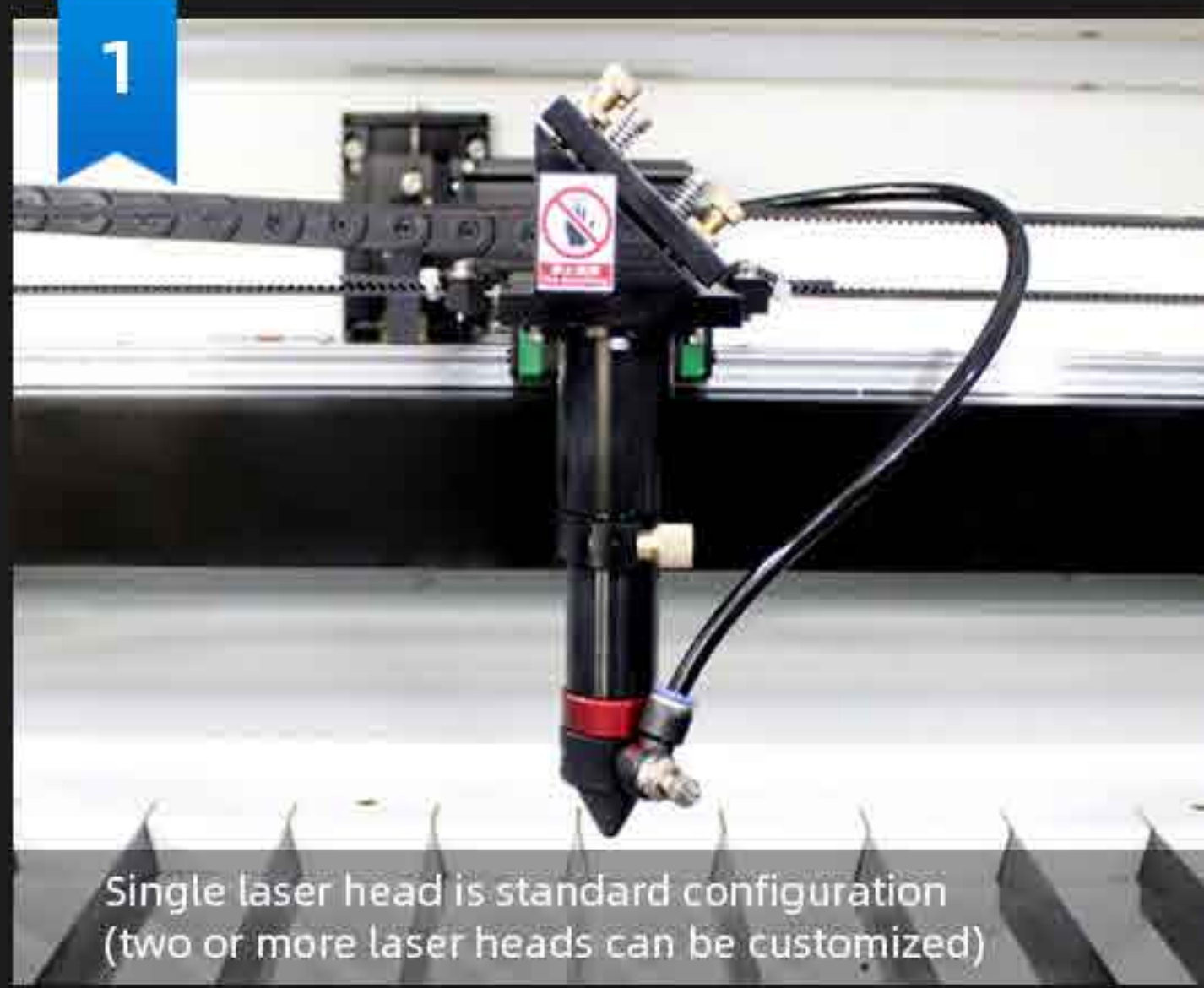

1300X900MM WORK AREA

laser cutting machine

HONEYCOMB WORKTABLE

- 1) Small holes make sure good supporting performance which is suitable for leather, cloth and other thin soft materials.
- 2) The hole of honeycomb worktable is small, so the small workpiece can be placed on the table surface to be processed.

INDUSTRIAL LASER HEAD

laser cutting machine

High precision retractable laser head, easy to adjust focal length, equipped with red light positioning system, accurate positioning, reduce material loss. Auto-blowing to protect laser head and prevent the laser burning

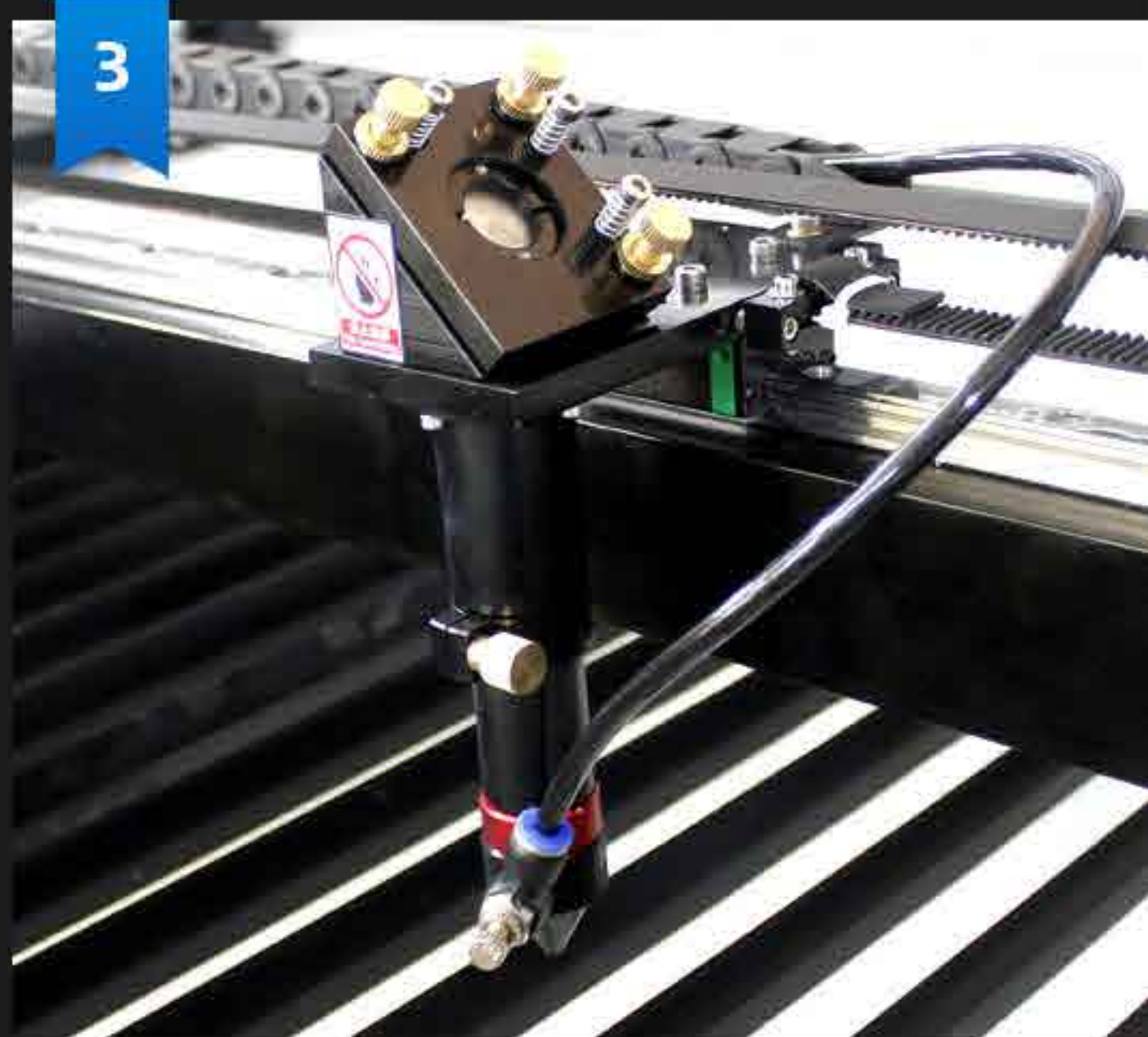

Laser is invisible, Red laser beam to determine the cut-off point

Laser Tube

laser cutting machine

Closed Co2 laser tube, long life, stable power. Installation of reinforcement settings, the laser tube is not easy to collide and cause damage when moving the machine. (EFR, RECI, CDWJ, YONGLI, JOY. Optional)



Bracket upgrade

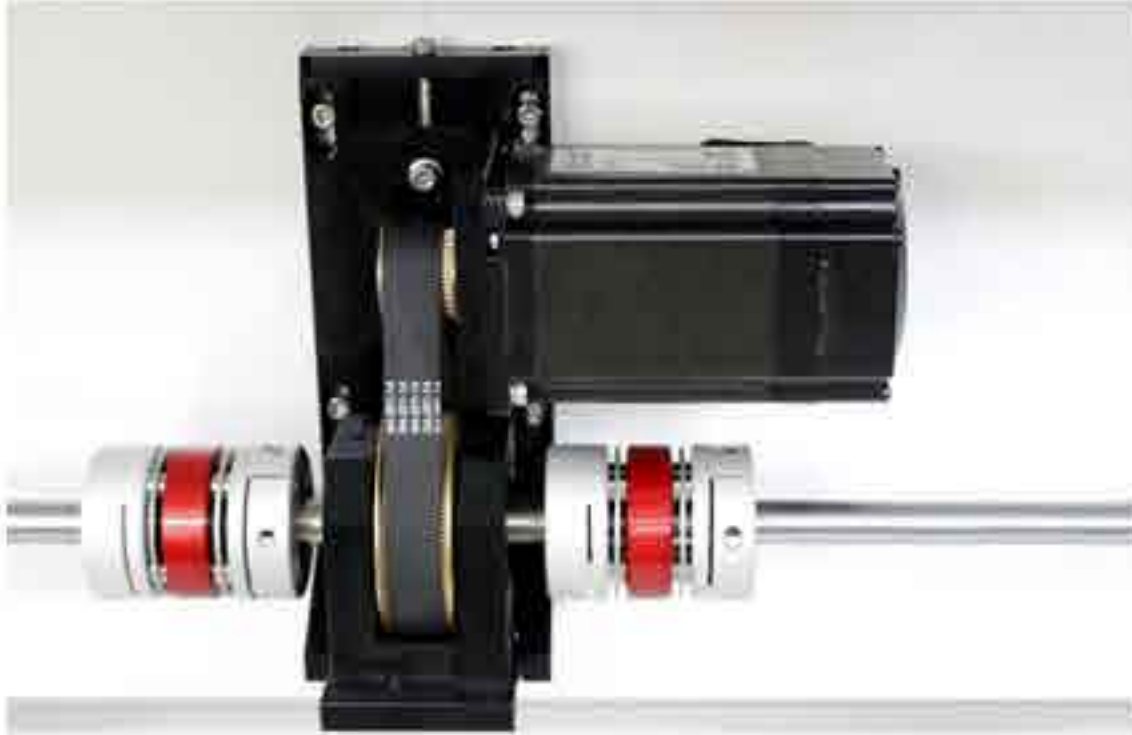

BRAND STEPPER MOTOR

High operating accuracy, high temperature resistance, can bear the high temperature generated by high-speed operation, and low noise.



MOTOR-DRIVER

- 1) self adaptive circuit
- 2) necessary accessories of off-line working



USA II-VI LENS

Imported USA II-VI Lens, suitable for various environments, and has high precision and high speed.



FAMOUS BRAND BELT

The ONK brand belt, wear resistance, good stability, compact structure and low noise.



FAMOUS BRAND SWITCH

laser cutting machine

LEADING CHAIN

laser cutting machine

The current lead and breather pipe are included in it.
Thicker, more stable
Keep the laser head from shaking



REFLECTOR

laser cutting machine

45°mirror adjustment set. Easy to adjust laser path.

SWITCH

laser cutting machine

key switch, emergency stop, LED light





FEATURES

laser cutting machine

1. Adopt advanced laser engraving and cutting control system: Ruida RDC6442 control system, the control panel support different language include Chinese, English, French, Pyccko, Portuguese, Turkish, German, Spanish, Vietnamese, Korean, Italian.
2. Standard RDWorksV8 software: It support 15 different languages, include: Chinese, English, Japanese, French, German, Portuguese, Polish, Spanish, Russian, Korean, Vietnamese, Indonesian, Italian, Turkish, Arabic.
It can compatible with many other software, like Coreldraw, Photoshop, AutoCAD, TAJIMA, etc.
You can use these software to make designs, then import to Rdworks to cut or engrave.
3. RDworks software support files in different format: AI, DXF, PLT, DST, BMP, DSB, EPS, DAT, NC, RDB, GIF, JPG, JPEG, JPE, JFIF, PNG, MNG, ICO, CUR, TIF, TIFF, TGA, PCX, WBMP, WMF, EMF, JBG, J2C, JPC, PGX, RAS, PNM, PGM, PPM, SKA, RAW,
4. Storage: The main board has EMS Memory which enables the user to store more than 100 files.
5. Laser output control: Can regulate the laser power from 1-100% according to different material.
6. Interface: USB2.0 interface support connect to computer by USB cable, it also support offline work.



Wifi Control(optional)



Mobile App(optional)



Multi-language

MAIN BOARD

laser cutting machine

Multi-language in LCD panel.
Ruida. The interface of the control panel is simple, easy to learn, easy to operate and the system is stable.



Free upgrade to RD-6445



USB interface

laser cutting machine

USB interface & USB cable. Two kinds of transmission files.

Imported linear guide

laser cutting machine

X Y axis apply imported square rails.
Ensures stable operation, high precision
and long life.



Distribution cabinet

laser cutting machine

Machine detail. Take every detail
seriously to ensure that the machine
is stable working during service to every customer.



Platform lifting

laser cutting machine

It allows you to process materials of various sizes,
can be lifted in Z direction (up-and-down) to get
more working space.

Front and back Feeding Doors

laser cutting machine

Front and back feeding material system, you can cut and engrave the material at the largest scale



Amperemeter

laser cutting machine

Coreldraw and CAD control directly

Advanced working software which can be embedded into Coreldraw and CAD, User can operate the machine buy Cor-edraw or CAD software directly.



Coreldraw



CAD



Rotary fixture

Rotary fixture Can engrave degree , usually applied in advertisement and craft work , for colum or cone work piecsurface (need work together with motorized Up and Down System) Rotary fixture is for the circle engravingof cylindrical or column work pieces Need working together with Motorized Up and Down System.

water chiller

Best in china, it is for cooling the laser tube after water fill in the pipe when machine is working



Exhaust fan

Removes smoke and dust caused during engraving and cutting



Water protection



Waste disposal drawer

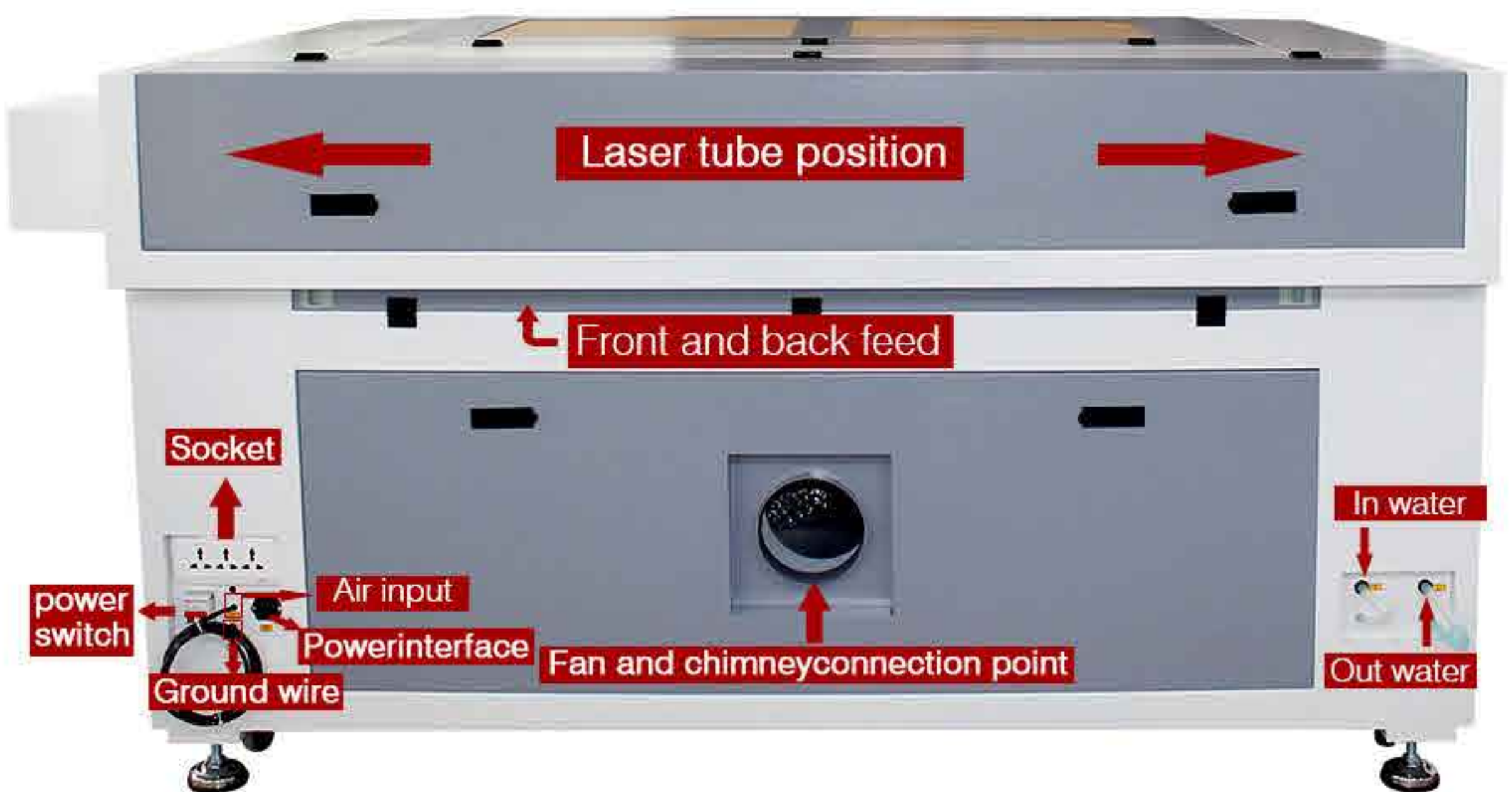

Laser tube position

Front and back feed

Socket

power switch

Air input

Powerinterface

Ground wire

Fan and chimney connection point

In water

Out water

Our certificate

Foster Laser Technology Co., Ltd.



PRODUCT DETAILS

LASER

LIAOCHENG FOSTER LASER SCIENCE & TECHNOLOGY CO., LTD.

Model	FST-1390
Worktable	honeycomb or blade
Engraving area	1300*900mm
Laser Power	60w/80w/ 100w/ 150w / 300w
Engraving Speed	0-60000mm/min
Engraving Depth	5mm
Cutting Speed	0-5000mm/min
Cutting Depth (Acrylic)	0-30mm (acrylic)
Up and down worktable	Up and down 550mm adjustable
Minimum Shaping Character	1 X 1mm
Resolution Ratio	0.0254mm (1000dpi)
Power Supply	220V(or110V)+/-10% 50Hz
Resetting Positioning	Accuracy less than or equal to 0.01mm
Water protecting sensor and alarm	Yes
Operating Temperature	0-45°C
Operating Humidity	35-70°C
Graphic Format Supported	PLT/DXF/BMP/JPG/GIF/PGN/TIF
Operation System	Windows XP/VISTA/Windows 7/8/10
Software	RDWorks/LaserCAD/AotuCAD
Control Configuration	DSP
Water Cooling(Yes/No)	Yes
Maximum Height Of Materials To Engrave(mm)	120mm
Laser Tube	Sealed CO2 glass laser tube
Machine Dimension	1840x1400x1030(mm)
Packing Dimension	2040x1600x1320mm
Gross Weight	410kg

PRODUCT ACCESSORIES

LASER

LIAOCHENG FOSTER LASER SCIENCE & TECHNOLOGY CO., LTD.



Air Pump



Chimney



Water pump



Tool protection



Data Line



CD or U disk



Focal length ruler



Power Cord



Tool box



Exhaust fan



Cardan wheel



Instruction Manual

Optional accessories



Simple rotary axis



Standard rotary axis



S&A Water chiller
CW-3000 / CW-5000

PRODUCT APPLICATION

LASER

LIAOCHENG FOSTER LASER SCIENCE & TECHNOLOGY CO., LTD.

Fosterlaser CO2 Laser Engraving Machine with different working area, laser power or working table, which application is engraving and cutting on acrylic, wood, fabric, cloth, leather, rubber plate, PVC, paper and other kinds of non metal materials.

1390 laser cutting machine are widely used in clothing, shoes, luggage, computer embroidery clipping, model, electronic appliances, toys, furniture, advertising decoration, packaging and printing, paper products, handicrafts, Household appliances, laser processing and other industries.



PACKAGING DELIVERY

LASER

LIAOCHENG FOSTER LASER SCIENCE & TECHNOLOGY CO., LTD.



Machine cleaning and
Protective oil processing



Wrapping with
protective film



Wooden box sealing



Container Sealing
and Transportation



container loading



Forklift moving goods

OUR REVIEWS

LASER

LIAOCHENG FOSTER LASER SCIENCE & TECHNOLOGY CO., LTD.

Supplier Service: **Very satisfied** (5 stars)
On-time Shipment: **Very satisfied** (5 stars)



9060 laser engraving machine

★★★★★

Great service from Fosterlaser.very quick to communomised and very well packaged. Easy to assemble an uracy is great.I would 100% recommend this compar



Supplier Service: **Acceptable** (3 stars)
On-time Shipment: **Very satisfied** (5 stars)



1390 LASER CUTTING MACHINE FOR METAL AND N...

★★★★★

very limited info, hard to get tech support. Didn't know I needed an oxygen cylindere, but machine is awesome.

Supplier Service: **Very satisfied** (5 stars)
On-time Shipment: **Very satisfied** (5 stars)

17 May 2020



6090 100 watt co2 laser engraving machine with ruid...

★★★★★

Product shipped super fast even during this covid-19 times when other sellers took ages. Everything came as described, and packed very well. If you want laser machine don't get it from anyone else.

0

Supplier Service: **Very satisfied** (5 stars)
On-time Shipment: **Very satisfied** (5 stars)

10 Jul 2020



1390 cnc co2 laser cutting machine with CCD camera...

★★★★★

Good quality built and good support from the seller. Nice machine all around. Just had to find a version of corel draw in english. Laser was well aligned despite shipping and didn't have to do alignment myself. So very satisfied all around. I prefer using some industrial water...

[Read more](#)

0

Supplier Service: **Very satisfied** (5 stars)
On-time Shipment: **Very satisfied** (5 stars)

12 Jun 2020



50w fiber laser marking machine 50w raycus with rot...

★★★★★

great service and trustworthy! will definitely buy again!!

0

Supplier Service: **Very satisfied** (5 stars)
On-time Shipment: **Very satisfied** (5 stars)

22 Jun 2020



laser engraving machine for perfume bottle 50w 4060...

★★★★★

the machine came with no scratches and no any damage, also the supplier was to active and helped me even after purchasing

0

Supplier Service: **Very satisfied** (5 stars)
On-time Shipment: **Very satisfied** (5 stars)

25 May 2020



Factory directly 150w 180w 220w RD6442S rect stainl...

★★★★★

wow just wow very great product. very satisfied customer here. the seller is very responsive..thank you so much

0

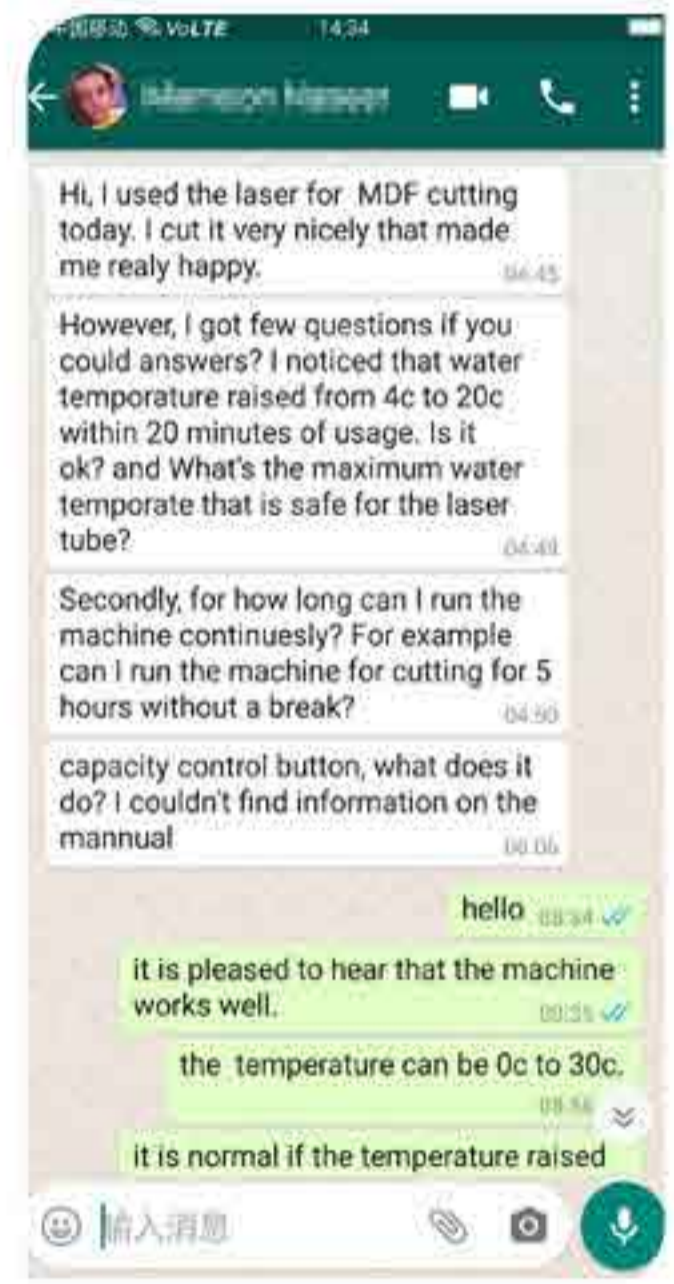

 Trade Assurance

Protect Your Alibaba.com Orders

Trade Assurance protects online orders when payment is made through Alibaba.com.

 Product Quality

 On Time Shipment



Company and Factory

Liaocheng Foster Laser Science&Technology Co.,Ltd is a professional manufacturer of laser engraving machine,laser cutting machine,laser marking machine for 12years .Since 2004, Foster Laser focused on the development and production of various types of laser engraving/cutting/marking machine with the advanced management,strong research strength and steady globalization strategy, Foster Laser establish more perfect product sales and service system in China and around the world, make the world's brand in laser industry.

Our target is "scientific management, high quality, high reputation and takes continuous development as our policy, regards customers as our center, double win with our customers", and we adhere to our tenet of "take the market demand as the guide, continue to take innovation and make improvement". We will try our best to provide the high quality products and perfect service for clients.

Furthermore,we pay much attention to after-sales service. Good service and good quality is same important for Foster Laser will follow the spirit "Credibility and Integrity", try best to provide customer more super product and better service.

Foster Laser--reliable professional Laser equipment supplier!

Welcome to cooperate with us and achieve win-win!



Office and Team



Our Exhibition

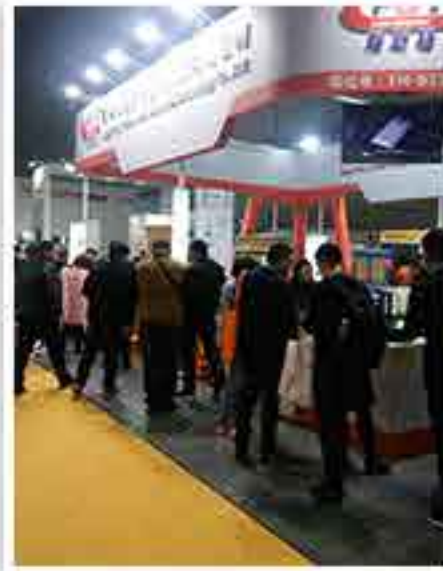
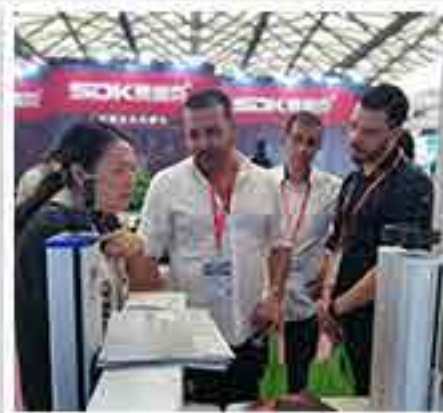
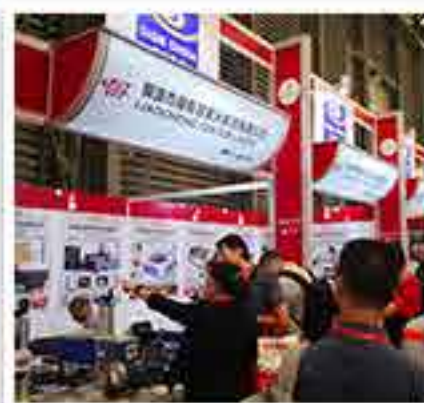
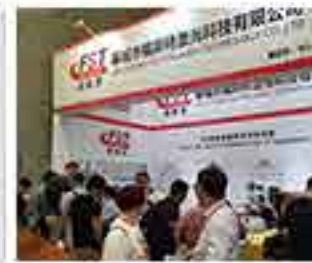
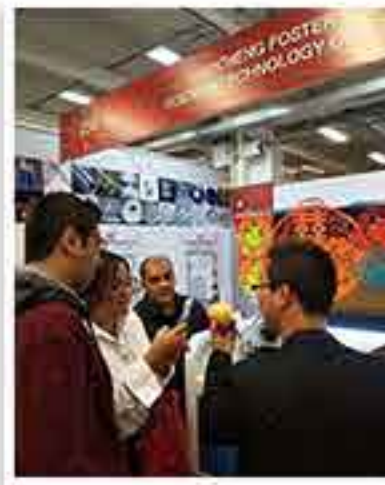
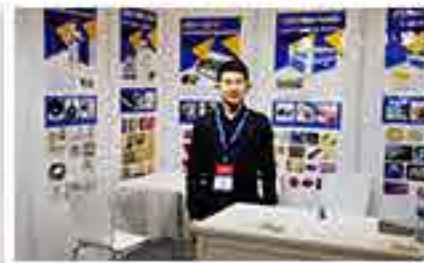



F A Q



Q1. Before sending me an inquiry on our cnc laser, it is better for you to provide me the following information:

- 1)Your metal or non-metal material size. Because in our factory, we have different models according to working area.
- 2)Your materials.
Metal/Acrylic/plywood/MDF?
- 3)You want to engrave or cut?
If cut, could you tell me your cutting thickness? Because different cutting thickness need different laser tube power and laser power supplier.

Q2. If we don't know how to use the machine,can you teach us?

Yes, We will send you manual and guide vedio in English, it can teach you how to operate the machine. If you still can not learn how to use it, we can help you by "Teamviewer" online helpsoftware.Or we can talk by phone, email or skype

Q3.How long is the delivery time?

For standard machines, it would be 3-5 days; For non-standard machines and customized machines according to client's specific requirements, it would be 7 to 10 days.

Q4. Quality Control:

The whole production procedure will be under regular inspection and strict quality control. The complete machine will be tested to make sure they can work very well before being out of factory. Our machine passed CE Certificate, meet European and American standard, were exported to more than 100 Countries.

Q5. Do you arrange shipment for the machines?

Yes, dear esteemed customers, for FOB or CIF price, we will arrange shipment for you. For EXW price, clients need to arrange shipment by themselves or their agents.

Our services

1. warranty for 1 years.
2. Maintenance for whole life.
3. We will provide the consumable parts at an agency price.
4. 24 hours online service, free technical support.
5. Machine has been adjusted before delivery, operation disk is included in the delivery. If there is any other questions, pls kindly tell me.
6. We have manual instruction and CD (Guiding Videos) for software Installation, operation and machine's using and maintenance.